



EXAL



EXTRUSORA DE ALUMINIO

2024

CATÁLOGO DE PERFILES

PROFILES CATALOG

WWW.EXAL.COM.CO



7 años de experiencia en extrusión



EST. 2016

Más de **25** años de trayectoria en el mercado del aluminio

Somos especialistas en la extrusión de aluminio para perfiles industriales arquitectónicos y de construcción.

Leading manufacturer of aluminum profiles with over 7 years of experience in the extrusion of profiles for the commercial and residential construction industries.

Empresa Colombiana ubicada en Barranquilla, Atlántico, con más de 7 años de experiencia en la extrusión de perfiles industriales. dedicada a la fabricación de perfiles de aluminio arquitectónicos para la construcción, la decoración y la industria.

Family owned and operated colombian company located in Barranquilla, Colombia, with over 7 years of experience in the aluminum extrusion business, dedicated to the manufacture of architectural aluminum profiles for construction, decoration and industry.



Fabricación de Tochos
Billet Manufacturing



Extrusión de Perfiles
Profile Extrusions



Acabado en Pintura
Powder Coating

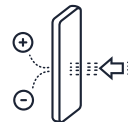

Acabado Anodizado
Anodizing

EXTRUSORA DE ALUMINIO



**EN EXAL
APORTAMOS A UNA
ECONOMÍA CIRCULAR**

At EXAL we contribute to a circular economy



Contamos con una línea de producción sostenible.

We have a sustainable production line.

Tabla de Contenido

Table of Contents

Sistemas Arquitectónicos | Architectural Systems

5020 5020 System	6
744 744 System	7
8025 8025 System	8
7038 7038 System	9
3831 3831 System	10

Perfiles Sólidos | Non-Hollow profiles

Platinas Plate	11
Barras cuadradas Squared Bars	12
Canales Channels	12
Canales con Aleta Channels with fin	12
Ángulos Angles	13
Tees Tees	13

Tubulares | Hollow profiles

Cuadrados Squared hollow tubes	14
Redondos Rounded hollow tubes	14
Rectangulares Rectangular hollow tubes	15
Con Aleta Hollow tubes with fin	16
Con Doble Aleta Hollow tubes with double fin	16
Con Adaptador Hollow tubes with Adapters	17
Tubolites Door Profile	17

Acabados Interior | Interior Finishes

Wing Wing	18
Pirlán escalera Stair ends	18
Persianas Blinds	18
Reticula Reticle	18

Pisavidrios <i>Glass Holders</i>	18
Esquineros <i>Cornerbacks</i>	19
Mosquitero <i>Mosquito Net</i>	19
Enchapes <i>Veneer</i>	19
Pasamanos <i>Handrails</i>	19
Divisiones de Baño <i>Bathroom Divisions</i>	20
Divisiones de Oficina <i>Office Divisions</i>	20
Riel de Closet <i>Closet Railing</i>	20
Zócalos <i>Skirting Boards</i>	21
Disipador de Calor <i>Heat Sink</i>	21

Perfiles de Exportación | *Exporting Profiles*

Perfiles Estandar <i>Standard Profiles</i>	22
Cerramiento de Patios <i>Patio Enclosures</i>	24
Energía Solar <i>Solar Energy</i>	26

Tipos de Acabados | *Finishes*



El material fabricado en nuestra planta de producción cumple con los siguientes rangos de propiedades mecánicas y composición química, las cuales se encuentran dentro de las tolerancias establecidas por la norma técnica **ASTM B221** "Standard Specification for Aluminum - Alloy Extruded Bars, Rods, Wire, Shapes and Tubes (Metric)"

The material manufactured in our production plant complies with the ranges of mechanical properties and chemical composition, which are within the tolerances established by the technical standard ASTM B221 "Standard Specification for Aluminum - Alloy Extruded Bars, Rods, Wire, Shapes and Tubes (Metric)"



Sistema 5020

5020 System

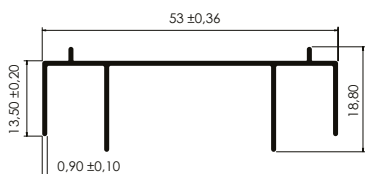

CABEZAL Head

REF.	Peso / Weight		PER.	
	kg/m	lb/ft	mm	in
EXA144	0.277	0.186	226.02	8.89

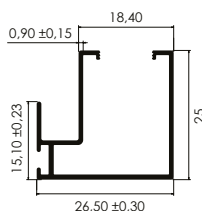

HOJA CENTRAL Interlocker

REF.	Peso / Weight		PER.	
	kg/m	lb/ft	mm	in
EXA147	0.252	0.169	200.81	7.90

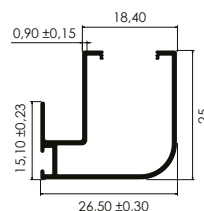

HOJA CENTRAL REDONDA Rounded Interlocker

REF.	Peso / Weight		PER.	
	kg/m	lb/ft	mm	in
EXAR147	0.260	0.174	193.31	7.61

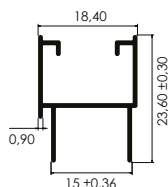

TRASLAPE Stile

REF.	Peso / Weight		PER.	
	kg/m	lb/ft	mm	in
EXA192	0.185	0.124	150.54	5.92

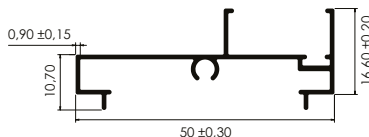

JAMBA Jamb

REF.	Peso / Weight		PER.	
	kg/m	lb/ft	mm	in
EXA193	0.279	0.187	222.48	8.77

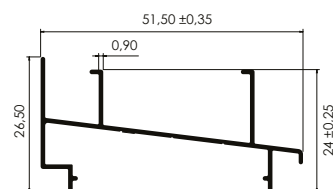

SILLAR Sill

REF.	Peso / Weight		PER.	
	kg/m	lb/ft	mm	in
EXA194	0.300	0.201	244	9.60

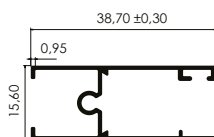

HOJA SUPERIOR/INFERIOR Top/Bottom Rail

REF.	Peso / Weight		PER.	
	kg/m	lb/ft	mm	in
EXA349	0.293	0.196	221.35	8.71

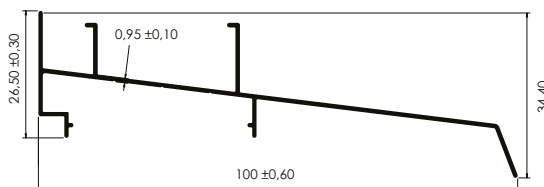

SILLAR CON ALFAJÍA Sill with a Drip

REF.	Peso / Weight		PER.	
	kg/m	lb/ft	mm	in
EXA581	0.450	0.302	351.61	13.84

Sistema 744

744 System

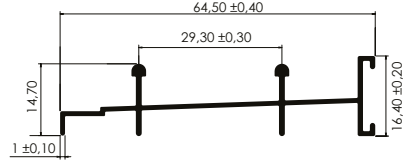

SILLAR Sill

REF.	Peso / Weight		PER.	
	kg/m	lb/ft	mm	in
EXA387	0.359	0.241	237.11	9.33

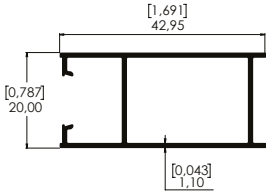

HOJA LATERAL Side Rail

REF.	Peso / Weight		PER.	
	kg/m	lb/ft	mm	in
EXA388	0.390	0.262	263.2	10.36

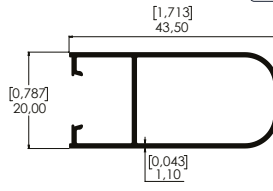

HOJA LATERAL REDONDA Rounded Side Rail

REF.	Peso / Weight		PER.	
	kg/m	lb/ft	mm	in
EXAR388	0.377	0.253	253.25	9.97

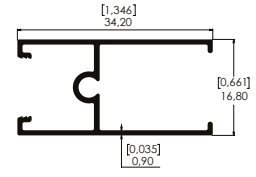

HOJA SUPERIOR Top Rail

REF.	Peso / Weight		PER.	
	kg/m	lb/ft	mm	in
EXA389	0.252	0.169	200.9	7.90

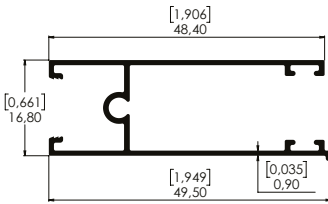

HOJA INFERIOR Bottom Rail

REF.	Peso / Weight		PER.	
	kg/m	lb/ft	mm	in
EXA390	0.348	0.176	275.31	10.83

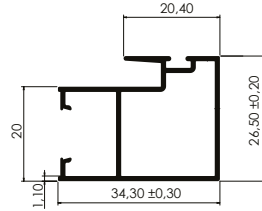

HOJA CENTRAL Interlocker

REF.	Peso / Weight		PER.	
	kg/m	lb/ft	mm	in
EXA391	0.415	0.278	274.85	10.82

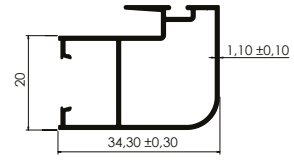

HOJA CENTRAL REDONDA Rounded Interlocker

REF.	Peso / Weight		PER.	
	kg/m	lb/ft	mm	in
EXAR391	0.407	0.273	269.6	10.61

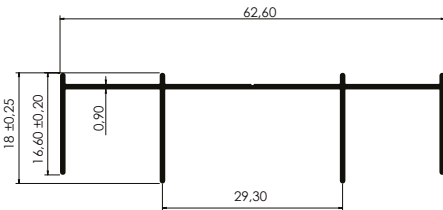

CABEZAL Head

REF.	Peso / Weight		PER.	
	kg/m	lb/ft	mm	in
EXA392	0.311	0.208	254.53	10.02

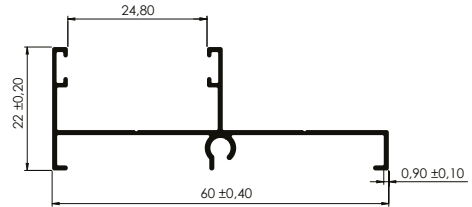

JAMBA Jamb

REF.	Peso / Weight		PER.	
	kg/m	lb/ft	mm	in
EXA393	0.314	0.210	252.83	9.95

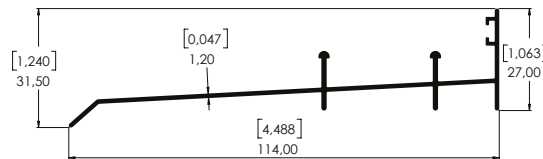

SILLAR CON ALFAJÍA Sill with a Drip

REF.	Peso / Weight		PER.	
	kg/m	lb/ft	mm	in
EXA394	0.602	0.404	358	14.09

Sistema 8025

8025 System

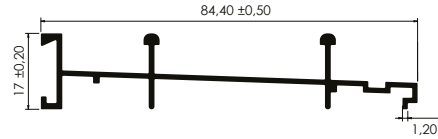

SILLAR Sill

REF.	Peso / Weight		PER.	
	kg/m	lb/ft	mm	in
EXA150	0.539	0.362	300.11	11.81

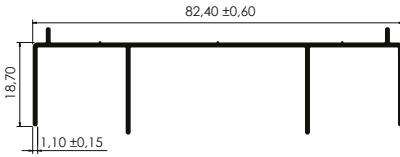

CABEZAL Head

REF.	Peso / Weight		PER.	
	kg/m	lb/ft	mm	in
EXA151	0.485	0.325	324.95	12.79

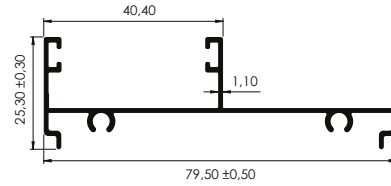

JAMBA Jamb

REF.	Peso / Weight		PER.	
	kg/m	lb/ft	mm	in
EXA841	0.518	0.348	327.29	12.88

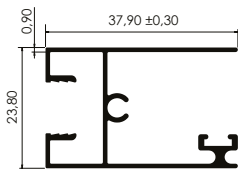

HOJA SUPERIOR Top Rail

REF.	Peso / Weight		PER.	
	kg/m	lb/ft	mm	in
EXA156	0.381	0.256	283.69	11.16

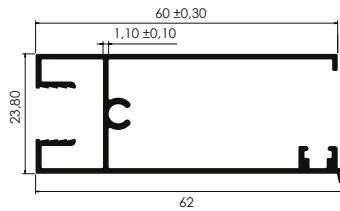

HOJA INFERIOR Bottom Rail

REF.	Peso / Weight		PER.	
	kg/m	lb/ft	mm	in
EXA157	0.604	0.405	381	15

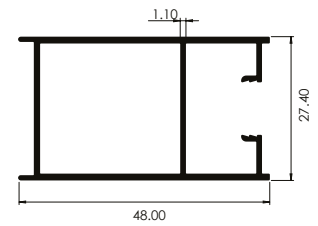

HOJA LATERAL Side Rail

REF.	Peso / Weight		PER.	
	kg/m	lb/ft	mm	in
EXA190	0.548	0.368	330.96	13.02

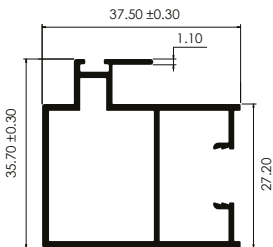

HOJA CENTRAL Interlocker

REF.	Peso / Weight		PER.	
	kg/m	lb/ft	mm	in
EXA191	0.562	0.377	339.1	13.35

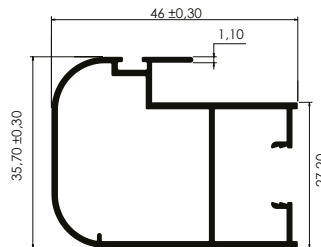

HOJA CENTRAL REDONDA Rounded Interlocker

REF.	Peso / Weight		PER.	
	kg/m	lb/ft	mm	in
EXA631	0.598	0.401	365.34	14.38

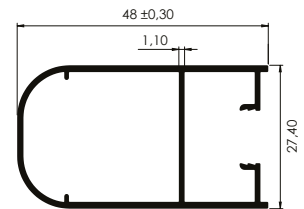

HOJA LATERAL REDONDA Rounded Side Rail

REF.	Peso / Weight		PER.	
	kg/m	lb/ft	mm	in
EXA633	0.530	0.356	320.88	12.63

Sistema 7038

7038 System

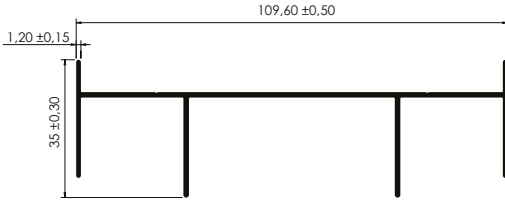

CABEZAL Head

REF.	Peso / Weight		PER.	
	kg/m	lb/ft	mm	in
EXA700	0.792	0.532	434.23	17.09

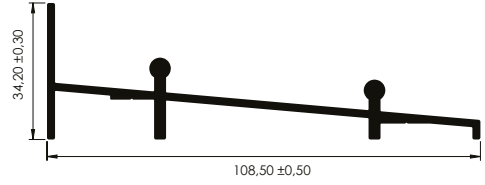

SILLAR Sill

REF.	Peso / Weight		PER.	
	kg/m	lb/ft	mm	in
EXA775	1.108	0.744	353.33	13.91

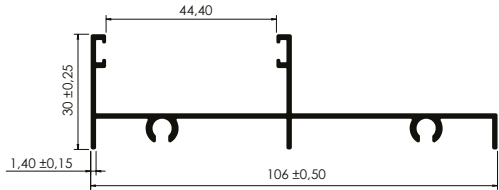

JAMBA Jamb

REF.	Peso / Weight		PER.	
	kg/m	lb/ft	mm	in
EXA702	0.826	0.555	412.72	16.24

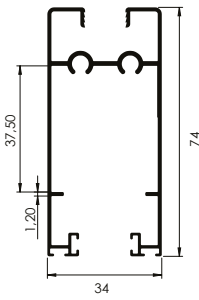

HOJA SUPERIOR/INFERIOR Top/Bottom Rail

REF.	Peso / Weight		PER.	
	kg/m	lb/ft	mm	in
EXA703	0.875	0.587	543.2	21.38

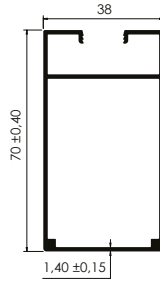

HOJA LATERAL Side Rail

REF.	Peso / Weight		PER.	
	kg/m	lb/ft	mm	in
EXA704	0.940	0.631	474.6	18.68

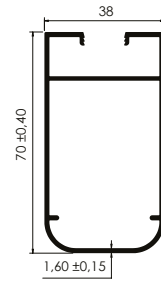

HOJA LATERAL REDONDA Rounded Side Rail

REF.	Peso / Weight		PER.	
	kg/m	lb/ft	mm	in
EXAR704	0.996	0.669	468.12	18.42

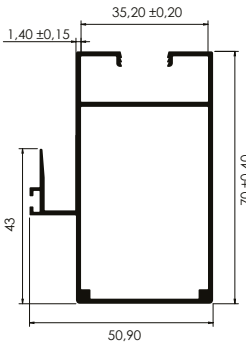

HOJA CENTRAL Interlocker

REF.	Peso / Weight		PER.	
	kg/m	lb/ft	mm	in
EXA705	1.060	0.712	543.7	21.40

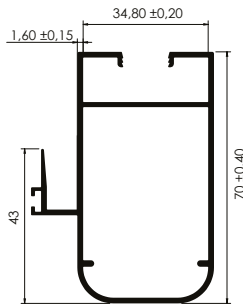

HOJA CENTRAL REDONDA Rounded Interlocker

REF.	Peso / Weight		PER.	
	kg/m	lb/ft	mm	in
EXAR705	1.128	0.757	536.41	21.11

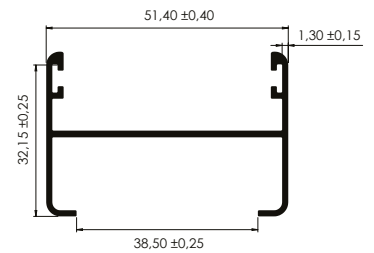

ADAPTADOR Adapter

REF.	Peso / Weight		PER.	
	kg/m	lb/ft	mm	in
EXA840	0.526	0.353	280.6	11.04

Sistema 3831

3831 System

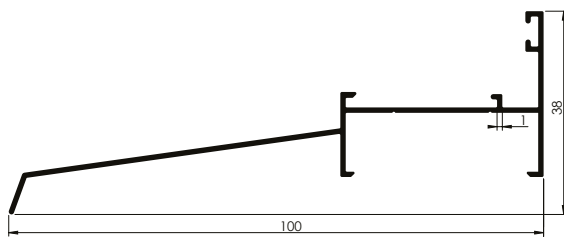

SILLAR CON ALFAJÍA Sill with a Drip

REF.	Peso / Weight		PER.	
	kg/m	lb/ft	mm	in
EXA626	0.450	0.302	330.7	13.02

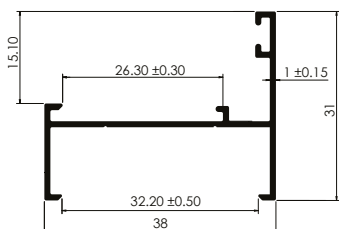

MARCO SUPERIOR/INFERIOR Top/Bottom Frame

REF.	Peso / Weight		PER.	
	kg/m	lb/ft	mm	in
EXA173	0.268	0.180	196.59	7.74

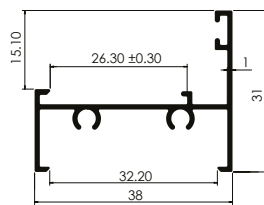

MARCO LATERAL Side Frame

REF.	Peso / Weight		PER.	
	kg/m	lb/ft	mm	in
EXA174	0.316	0.212	225.8	8.89

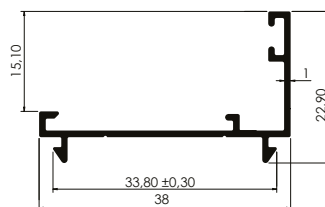

ADAPTADOR Adapter

REF.	Peso / Weight		PER.	
	kg/m	lb/ft	mm	in
EXA175	0.222	0.149	159.76	6.28

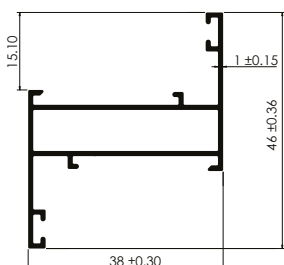

MARCO NAVE Frame

REF.	Peso / Weight		PER.	
	kg/m	lb/ft	mm	in
EXA176	0.432	0.290	312.26	12.29

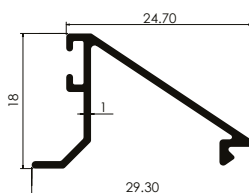

PISAVIDRIO PLANO Flat Glazing

REF.	Peso / Weight		PER.	
	kg/m	lb/ft	mm	in
EXA177	0.169	0.113	119.71	4.71

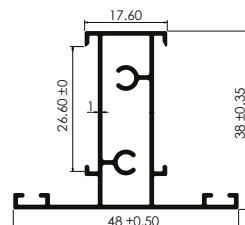

DIVISOR Divider

REF.	Peso / Weight		PER.	
	kg/m	lb/ft	mm	in
EXA292	0.522	0.350	376.66	14.82

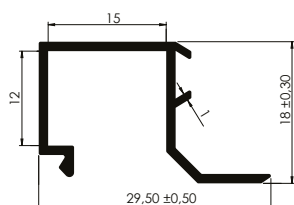

PISAVIDRIO CUADRADO Squared Glazing

REF.	Peso / Weight		PER.	
	kg/m	lb/ft	mm	in
EXA414	0.218	0.146	136.74	5.38

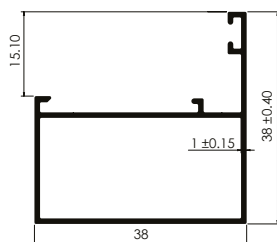

ESQUINERO Cornerback

REF.	Peso / Weight		PER.	
	kg/m	lb/ft	mm	in
EXA416	0.395	0.265	287.8	11.33

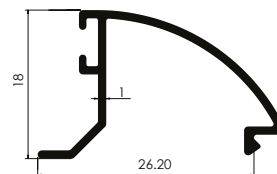

PISAVIDRIO CURVO Curved Glazing

REF.	Peso / Weight		PER.	
	kg/m	lb/ft	mm	in
EXA635	0.175	0.117	126.9	4.99

Perfiles Sólidos

Non-Hollow Profiles

Platinas Plate

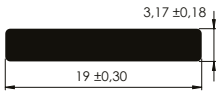

PLATINA DE 3/4" 3/4" Plate

REF.	Peso / Weight		PER.	
	kg/m	lb/ft	mm	in
P012	0.162	0.108	43.48	1.71

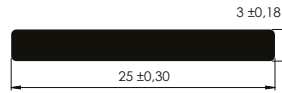

PLATINA DE 1" 1" Plate

REF.	Peso / Weight		PER.	
	kg/m	lb/ft	mm	in
P018	0.216	0.145	55.14	2.17

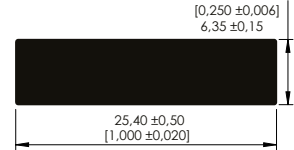

PLATINA DE 1" x 1/4" 1" x 1/4" Plate

REF.	Peso / Weight		PER.	
	kg/m	lb/ft	mm	in
P020	0.437	0.294	63.07	2.48

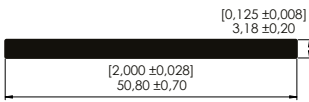

PLATINA DE 2" x 1/8" 2" x 1/8" Plate

REF.	Peso / Weight		PER.	
	kg/m	lb/ft	mm	in
P040	0.437	0.294	107.52	4.23

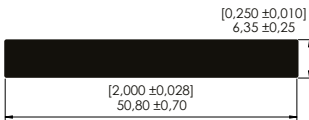

PLATINA DE 2" x 1/4" 2" x 1/4" Plate

REF.	Peso / Weight		PER.	
	kg/m	lb/ft	mm	in
P041	0.874	0.587	113.87	4.48

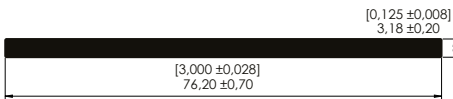

PLATINA DE 3" x 1/8" 3" x 1/8" Plate

REF.	Peso / Weight		PER.	
	kg/m	lb/ft	mm	in
P051	0.655	0.440	158.32	6.23

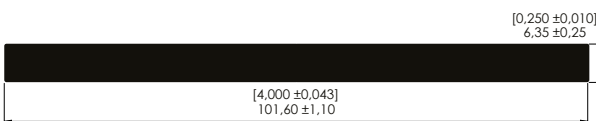

PLATINA DE 4" x 1/4" 4" x 1/4" Plate

REF.	Peso / Weight		PER.	
	kg/m	lb/ft	mm	in
P060	1.748	1.175	215.47	8.48

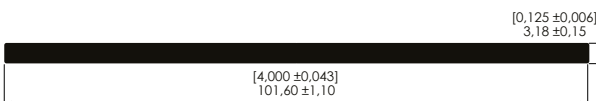

PLATINA DE 4" x 1/8" 4" x 1/8" Plate

REF.	Peso / Weight		PER.	
	kg/m	lb/ft	mm	in
P061	1.748	1.175	215.47	8.48



PLATINA DE 105mm x 7.8mm 105mm x 7.8mm Plate

REF.	Peso / Weight		PER.	
	kg/m	lb/ft	mm	in
PLA001	2.219	1.491	224.8	8.85

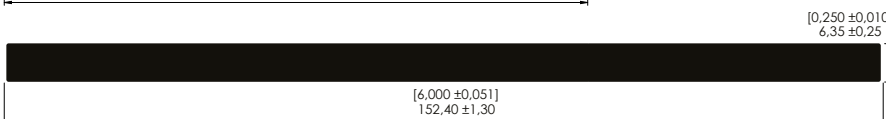

PLATINA DE 6" x 1/4" 6" x 1/4" Plate

REF.	Peso / Weight		PER.	
	kg/m	lb/ft	mm	in
PLA002	2.622	1.762	317.07	12.48

Barra Cuadrada

Squared Bars

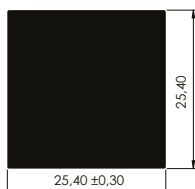

BARRA DE 1" 1" Bar

REF.	Peso / Weight		PER.	
	kg/m	lb/ft	mm	in
C009	1.748	1.17	101.1	3.98

Canales Channels

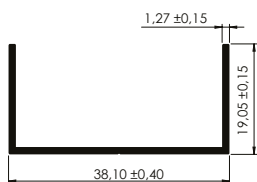

CANAL DE 1-1/2" x 3/4" 1-1/2" x 3/4" Channel

REF.	Peso / Weight		PER.	
	kg/m	lb/ft	mm	in
ESC001	0.253	0.170	149.28	5.87

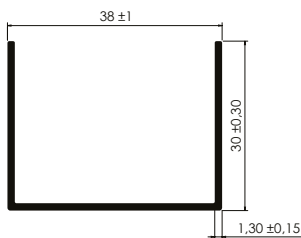

CANAL 38mm x 30mm 38mm x 30mm Channel

REF.	Peso / Weight		PER.	
	kg/m	lb/ft	mm	in
EXA1870	0.336	0.225	192.2	7.56

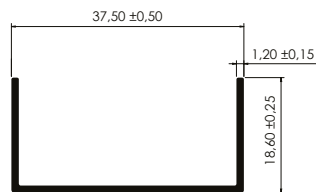

CANAL 37.4mm x 18.6mm 37.4mm x 18.6mm Channel

REF.	Peso / Weight		PER.	
	kg/m	lb/ft	mm	in
EXA1872	0.235	0.157	145.8	5.74

Canales con Aleta Channels with fin

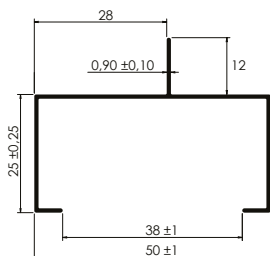

CANAL 2" x 1" 2" x 1" Channel

REF.	Peso / Weight		PER.	
	kg/m	lb/ft	mm	in
U066	0.293	0.196	140.1	5.51

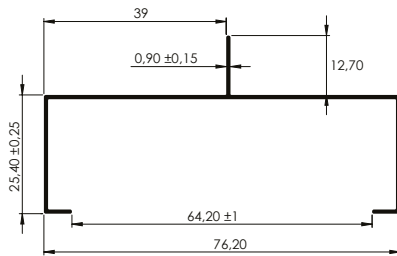

CANAL 3" x 1" 3" x 1" Channel

REF.	Peso / Weight		PER.	
	kg/m	lb/ft	mm	in
U078	0.361	0.242	295.64	11.64

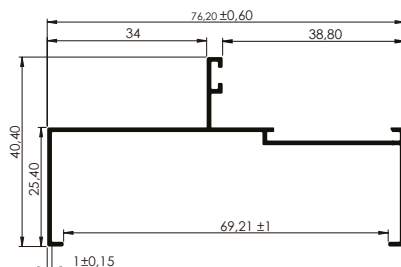

CANAL 3" x 1" ESPECIAL 3" x 1" Channel

REF.	Peso / Weight		PER.	
	kg/m	lb/ft	mm	in
U078E	0.429	0.288	314.62	12.38

Ángulos *Angles*

Tees *Tees*

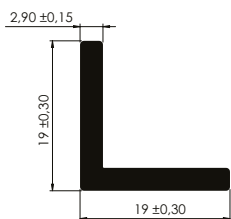

ÁNGULO DE 3/4" 3/4" Angle

REF.	Peso / Weight		PER.	
	kg/m	lb/ft	mm	in
A006	0.275	0.184	74.9	2.94

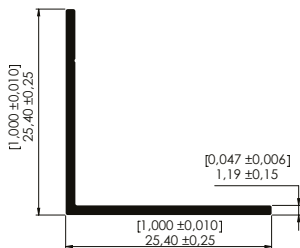

ÁNGULO DE 1" 1" Angle

REF.	Peso / Weight		PER.	
	kg/m	lb/ft	mm	in
A009	0.160	0.107	101.02	3.97

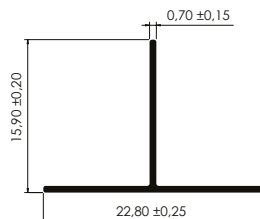

TEE CIELO RASO Low Ceiling Tee

REF.	Peso / Weight		PER.	
	kg/m	lb/ft	mm	in
D028	0.072	0.048	76.54	3.01

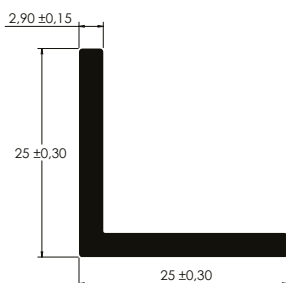

ÁNGULO DE 1" 1" Angle

REF.	Peso / Weight		PER.	
	kg/m	lb/ft	mm	in
A011	0.370	0.248	99.03	3.89

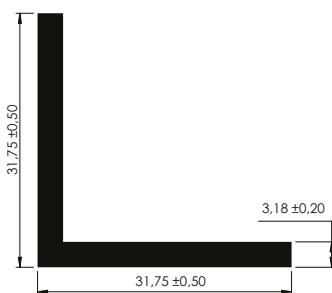

ÁNGULO DE 1-1/4" 1-1/4" Angle

REF.	Peso / Weight		PER.	
	kg/m	lb/ft	mm	in
A015	0.518	0.348	127	5

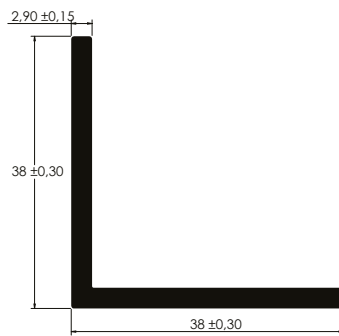

ÁNGULO DE 1-1/2" 1-1/2" Angle

REF.	Peso / Weight		PER.	
	kg/m	lb/ft	mm	in
A019	0.574	0.385	151	5.94

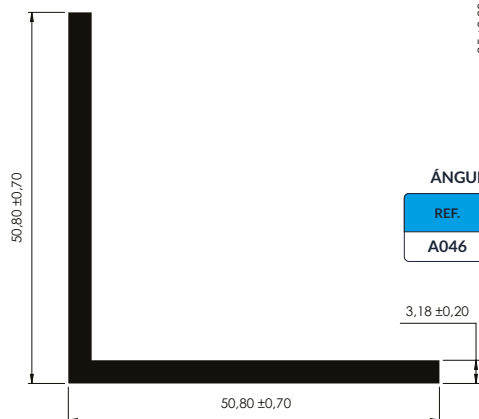

ÁNGULO DE 2" 2" Angle

REF.	Peso / Weight		PER.	
	kg/m	lb/ft	mm	in
A027	0.845	0.567	203.2	8

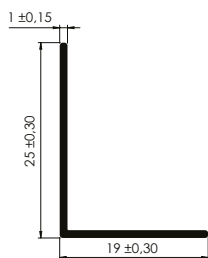

ÁNGULO DE 1" x 3/4" 1" x 3/4" Angle

REF.	Peso / Weight		PER.	
	kg/m	lb/ft	mm	in
A046	0.116	0.077	87.1	3.42

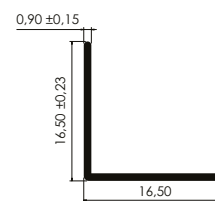

ÁNGULO CIELO RASO Low Ceiling Angle

REF.	Peso / Weight		PER.	
	kg/m	lb/ft	mm	in
A059	0.078	0.052	64.97	2.55

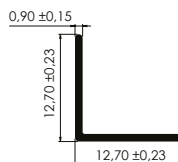

ÁNGULO DE 1/2" 1/2" Angle

REF.	Peso / Weight		PER.	
	kg/m	lb/ft	mm	in
A061	0.059	0.039	49.71	1.95

Perfiles Tubulares

Hollow Profiles

Cuadrados Squared Hollow Tubes

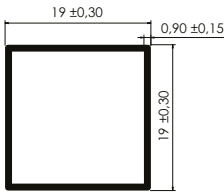

TUBO 3/4" 3/4" Hollow Tube

REF.	Peso / Weight		PER.	
	kg/m	lb/ft	mm	in
T115	0.176	0.118	144.1	5.67

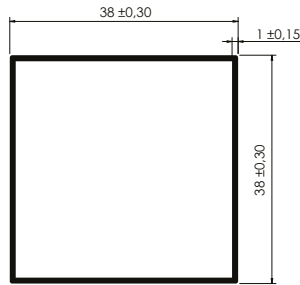

TUBO 1-1/2" 1-1/2" Hollow Tube

REF.	Peso / Weight		PER.	
	kg/m	lb/ft	mm	in
T215	0.401	0.269	295.31	11.62

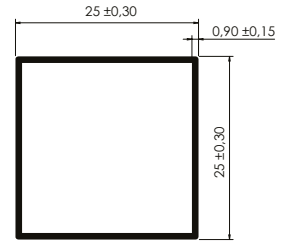

TUBO 1" 1" Hollow Tube

REF.	Peso / Weight		PER.	
	kg/m	lb/ft	mm	in
T216	0.235	0.157	192.11	7.56

Redondos Rounded Hollow Tubes

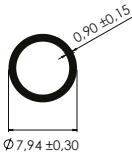

TUBO 5/16" 5/16" Hollow Tube

REF.	Peso / Weight		PER.	
	kg/m	lb/ft	mm	in
TC002	0.054	0.036	44.23	1.74

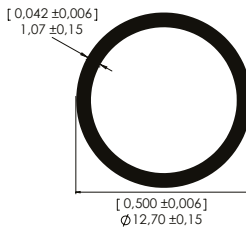

TUBO 1/2" 1/2" Hollow Tube

REF.	Peso / Weight		PER.	
	kg/m	lb/ft	mm	in
TC008	0.106	0.071	73.07	2.87

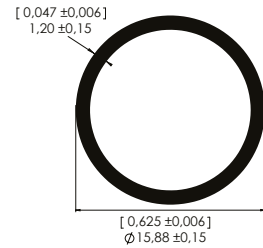

TUBO 5/8" 5/8" Hollow Tube

REF.	Peso / Weight		PER.	
	kg/m	lb/ft	mm	in
TC012	0.150	0.101	92.21	3.63

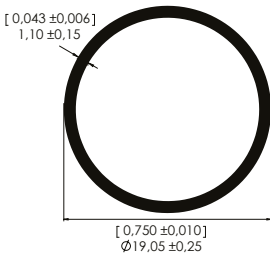

TUBO 3/4" 3/4" Hollow Tube

REF.	Peso / Weight		PER.	
	kg/m	lb/ft	mm	in
TC013	0.168	0.113	112.78	4.44

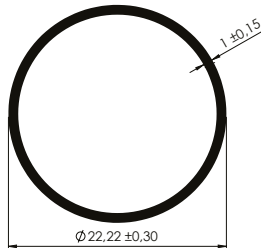

TUBO 7/8" 7/8" Hollow Tube

REF.	Peso / Weight		PER.	
	kg/m	lb/ft	mm	in
TC017	0.181	0.121	133.3	5.24

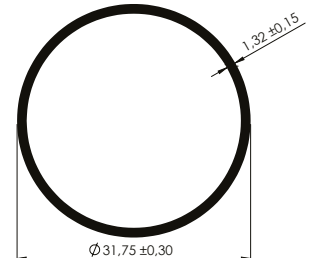

TUBO 1-1/4" 1-1/4" Hollow Tube

REF.	Peso / Weight		PER.	
	kg/m	lb/ft	mm	in
TC027	0.342	0.229	191.2	7.52

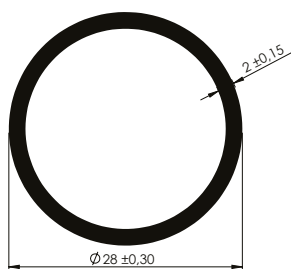

TUBO 1-1/4" 1-1/4" Hollow Tube

REF.	Peso / Weight		PER.	
	kg/m	lb/ft	mm	in
TC028	0.441	0.296	163.36	6.43

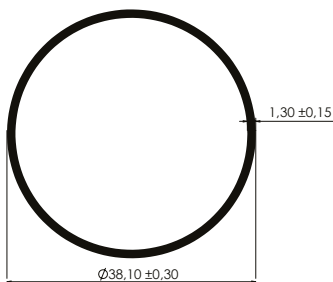

TUBO 1-1/2" 1-1/2" Hollow Tube

REF.	Peso / Weight		PER.	
	kg/m	lb/ft	mm	in
TC031	0.407	0.273	231.2	9.10

Rectangulares Rectangular Hollow Tubes

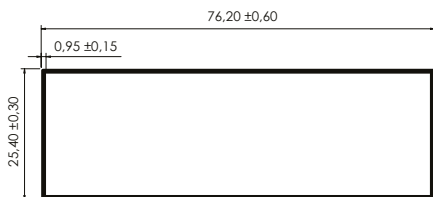

TUBO 3" x 1" 3" x 1" Hollow Tube

REF.	Peso / Weight		PER.	
	kg/m	lb/ft	mm	in
T094	0.513	0.345	398.1	15.67

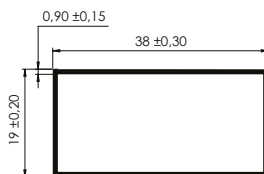

TUBO 1-1/2" x 3/4" 1-1/2" x 3/4" Hollow Tube

REF.	Peso / Weight		PER.	
	kg/m	lb/ft	mm	in
T097	0.269	0.180	220	8.66

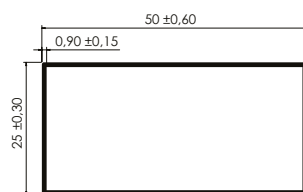

TUBO 2" x 1" 2" x 1" Hollow Tube

REF.	Peso / Weight		PER.	
	kg/m	lb/ft	mm	in
T117	0.357	0.239	292.11	11.50

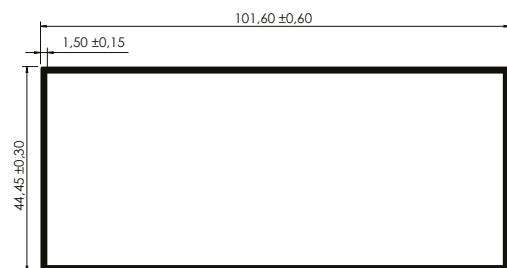

TUBO 4" x 1-3/4" 4" x 1-3/4" Hollow Tube

REF.	Peso / Weight		PER.	
	kg/m	lb/ft	mm	in
T101	1.163	0.781	571.52	22.50

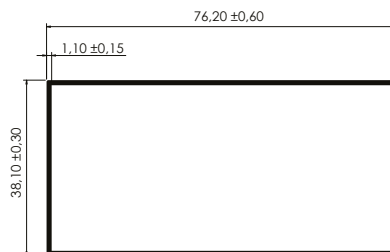

TUBO 3" x 1-1/2" 3" x 1-1/2" Hollow Tube

REF.	Peso / Weight		PER.	
	kg/m	lb/ft	mm	in
T103	0.668	0.448	447.71	17.62

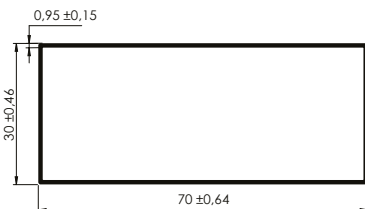

BOQUILLERA 70mm x 30mm 70mm x 30mm Hollow Tube

REF.	Peso / Weight		PER.	
	kg/m	lb/ft	mm	in
T167	0.505	0.339	391.28	15.40

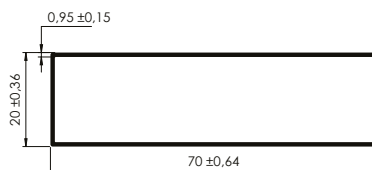

BOQUILLERA 70mm x 20mm 70mm x 20mm Hollow Tube

REF.	Peso / Weight		PER.	
	kg/m	lb/ft	mm	in
T168	0.453	0.304	351.28	13.82

Con Aleta *Hollow Tubes with Fins*

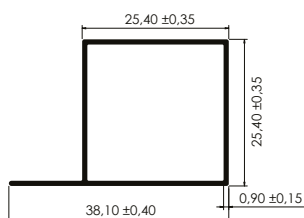

TUBO 1" CON ALETA 1" Hollow Tube with Fin

REF.	Peso / Weight		PER.	
	kg/m	lb/ft	mm	in
T077	0.270	0.181	219.96	8.66

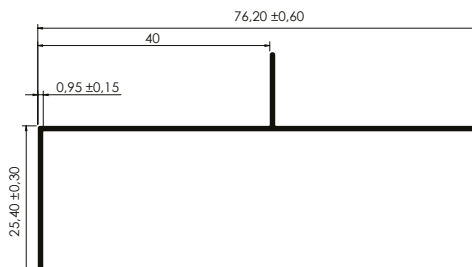

TUBO 3" x 1" CON ALETA 3" x 1" Hollow Tube with Fin

REF.	Peso / Weight		PER.	
	kg/m	lb/ft	mm	in
T095	0.545	0.366	422.72	16.64

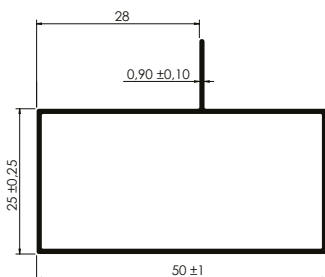

TUBO 2" x 1" CON ALETA DESCENTRADA
2" x 1" Hollow Tube with Offset Fin

REF.	Peso / Weight		PER.	
	kg/m	lb/ft	mm	in
TA037	0.386	0.259	315.1	12.40

Con Doble Aleta *Hollow Tubes with Double Fins*

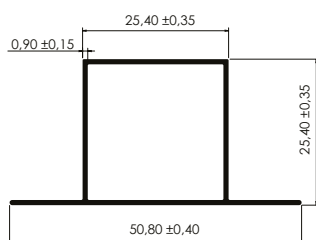

TUBO 1" CON DOBLE ALETA
1" Hollow Tube with double Fin

REF.	Peso / Weight		PER.	
	kg/m	lb/ft	mm	in
T078	0.301	0.202	245.17	9.65

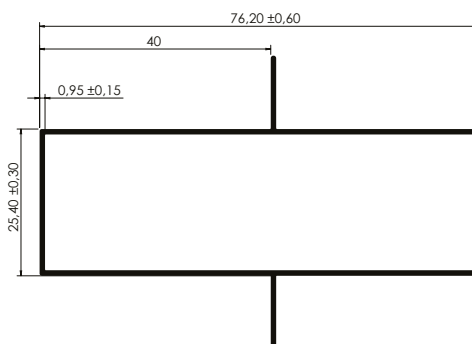

TUBO 3" x 1" CON DOBLE ALETA 3" x 1" Hollow Tube with double Fin

REF.	Peso / Weight		PER.	
	kg/m	lb/ft	mm	in
T096	0.578	0.388	447.6	17.62

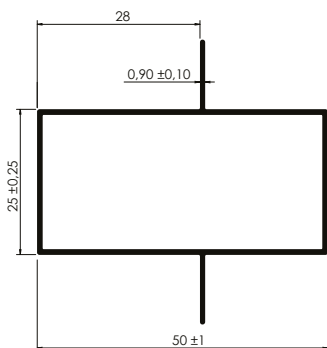

TUBO 2" x 1" CON DOBLE ALETA DESCENTRADA
2" x 1" Hollow Tube with Double Offset Fin

REF.	Peso / Weight		PER.	
	kg/m	lb/ft	mm	in
TA100	0.594	0.399	339.38	13.36

Tubolites Door Profile

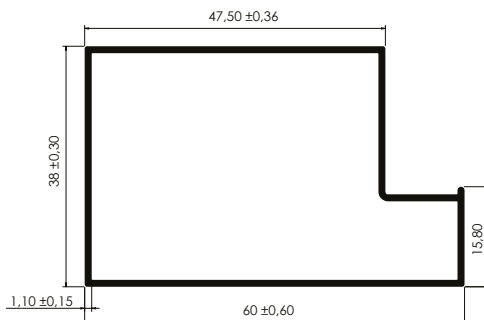

TUBOLITE Tubulite

REF.	Peso / Weight		PER.	
	kg/m	lb/ft	mm	in
TA005	0.573	0.385	383.24	15.08

Con Adaptador Hollow Tubes with Adapters

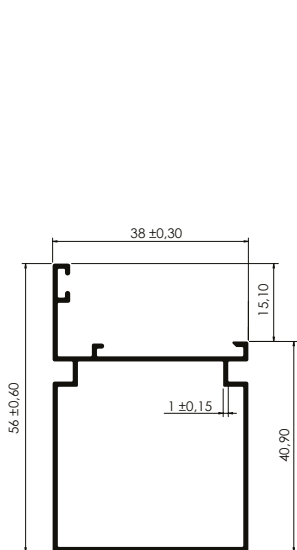

TUBO 1-1/2" CON ADAPTADOR
1-1/2" Hollow tube with Adapter

REF.	Peso / Weight		PER.	
	kg/m	lb/ft	mm	in
EXA1101	0.514	0.345	373.99	14.72

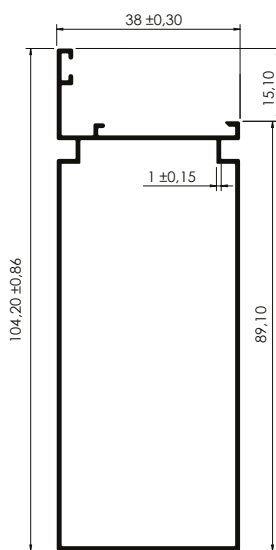

TUBO 3" x 1" CON ADAPTADOR
3" x 1" Hollow tube with Adapter

REF.	Peso / Weight		PER.	
	kg/m	lb/ft	mm	in
EXA1102	0.775	0.520	566.79	22.31

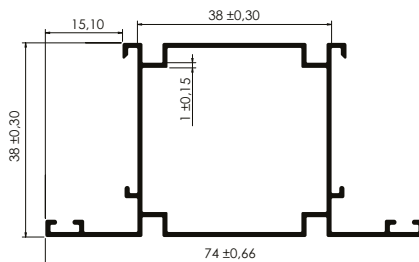

TUBO 1-1/2" CON DOBLE ADAPTADOR
1-1/2" Hollow tube with Double Adapter

REF.	Peso / Weight		PER.	
	kg/m	lb/ft	mm	in
EXA1103	0.627	0.421	453.1	17.83

Perfiles de Acabados Interior

Interior Finishes Profiles

Wing

Wing

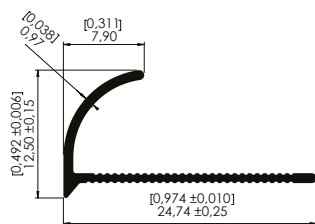

WING ESPAÑOL

Spanish Wing

REF.	Peso / Weight		PER.	
	kg/m	lb/ft	mm	in
CEO031	0.097	0.065	86.38	3.40

Pirlán

Escalera

Stair Ends

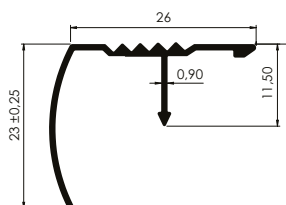

PIRLAN ESCALERA

Stair End

REF.	Peso / Weight		PER.	
	kg/m	lb/ft	mm	in
S390	0.186	0.124	130	5.11

Retícula

Reticle

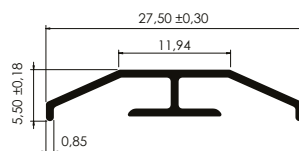

RETÍCULA

Reticle

REF.	Peso / Weight		PER.	
	kg/m	lb/ft	mm	in
EXA511	0.102	0.068	88.79	3.49

Persianas

Blinds

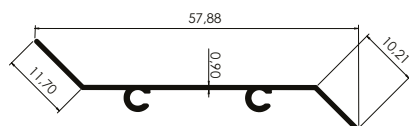

PERSIANAS

Blinds

REF.	Peso / Weight		PER.	
	kg/m	lb/ft	mm	in
EXA315	0.193	0.129	150.62	5.92

Pisavidrios

Glass Holders

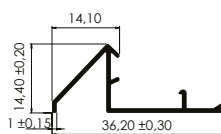

PISAVIDRIO HEMBRA

Glass Holder (Female)

REF.	Peso / Weight		PER.	
	kg/m	lb/ft	mm	in
S343	0.175	0.117	127.98	5.03

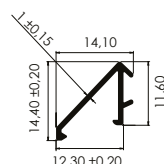

PISAVIDRIO MACHO

Glass Holder (Male)

REF.	Peso / Weight		PER.	
	kg/m	lb/ft	mm	in
S344	0.094	0.063	68.92	2.71

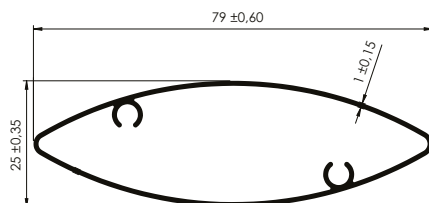

PERSIANA CORTASOL

Sun Blinds

REF.	Peso / Weight		PER.	
	kg/m	lb/ft	mm	in
T237	0.521	0.350	374.62	14.75

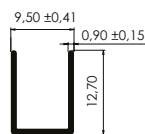

CANAL 3/8" x 1/2"

3/8" x 1/2" Channel

REF.	Peso / Weight		PER.	
	kg/m	lb/ft	mm	in
U068	0.080	0.053	66.67	2.62

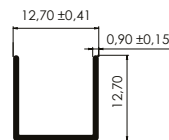

CANAL 1/2" x 1/2"

1/2" x 1/2" Channel

REF.	Peso / Weight		PER.	
	kg/m	lb/ft	mm	in
U074	0.088	0.059	73.07	2.87

Esquineros *Cornerbacks*

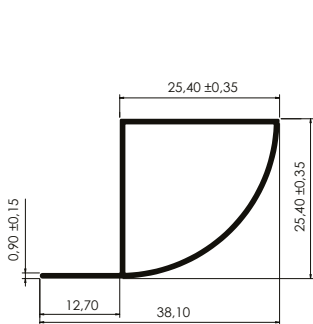

ESQUINERO 1" CON ALETA
1" Cornerback with wing

REF.	Peso / Weight		PER.	
	kg/m	lb/ft	mm	in
T281	0.244	0.164	199.1	7.83

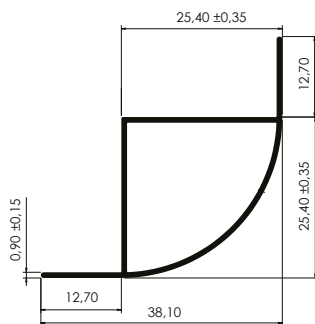

ESQUINERO 1" CON DOBLE ALETA
1" Cornerback with double wing

REF.	Peso / Weight		PER.	
	kg/m	lb/ft	mm	in
T282	0.274	0.184	224.1	8.82

Mosquitero *Mosquito Net*

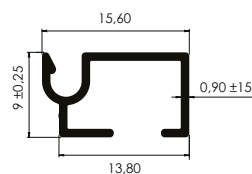

MOSQUITERO
Mosquito Net

REF.	Peso / Weight		PER.	
	kg/m	lb/ft	mm	in
EXA165	0.103	0.069	83.7	3.29

Enchapes *Veneer*

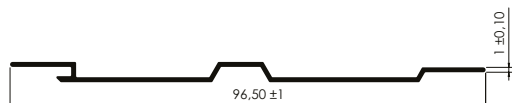

ENCHAPE PLANO
Flat Veneer

REF.	Peso / Weight		PER.	
	kg/m	lb/ft	mm	in
F006	0.291	0.195	214.43	8.44

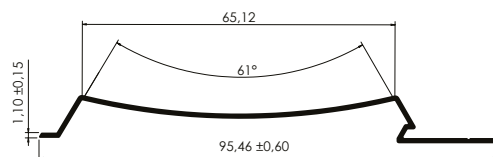

ENCHAPE CURVO
Curved Veneer

REF.	Peso / Weight		PER.	
	kg/m	lb/ft	mm	in
F007	0.291	0.195	214.43	8.44

Pasamanos *Handrails*

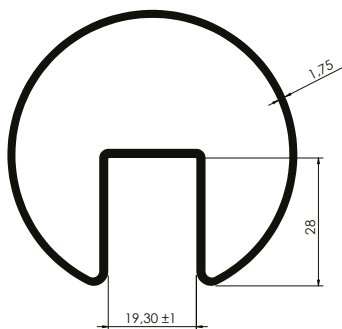

PASAMANOS 2-1/2"
2-1/2" Handrail

REF.	Peso / Weight		PER.	
	kg/m	lb/ft	mm	in
EXA736	1.221	0.820	492.52	19.39

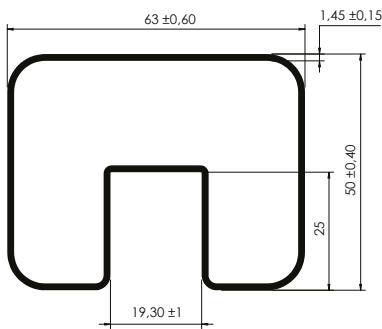

PASAMANOS ANATOMICO
Anatomic Handrail

REF.	Peso / Weight		PER.	
	kg/m	lb/ft	mm	in
EXA737	1.001	0.672	509.5	20.05

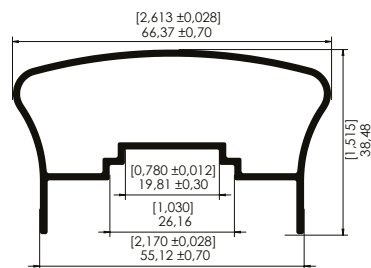

PASAMANOS TOP CAP
Top Cap Handrail

REF.	Peso / Weight		PER.	
	kg/m	lb/ft	mm	in
TOP001	0.800	0.538	389.15	15.32

NUEVO

Divisiones de Baño *Bathroom Divisions*

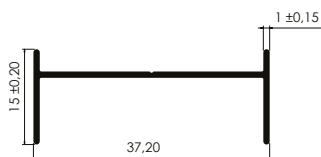

MARCO LATERAL
Side Frame

REF.	Peso / Weight		PER.	
	kg/m	lb/ft	mm	in
EXA343	0.175	0.117	130.43	5.13

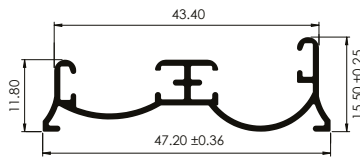

GUÍA INFERIOR VT
VT Bottom Rail

REF.	Peso / Weight		PER.	
	kg/m	lb/ft	mm	in
EXA1768	0.304	0.204	218.2	8.59

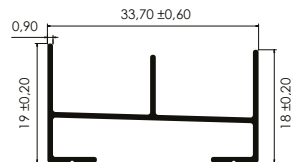

SILLAR
Sill

REF.	Peso / Weight		PER.	
	kg/m	lb/ft	mm	in
S597	0.224	0.150	183.4	7.22

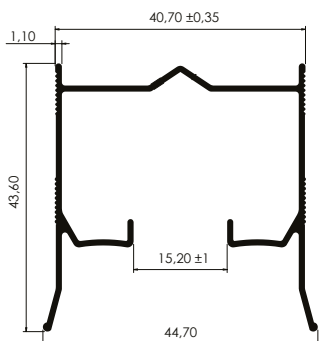

RIEL COLGANTE
Hanging Rail

REF.	Peso / Weight		PER.	
	kg/m	lb/ft	mm	in
EXA346	0.450	0.302	326.61	12.85

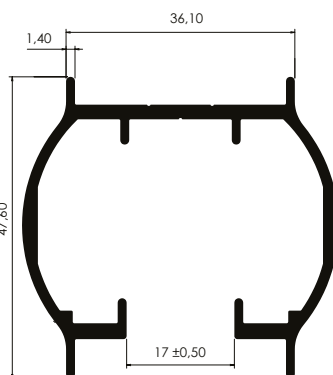

RIEL COLGANTE VT
VT Hanging Rail

REF.	Peso / Weight		PER.	
	kg/m	lb/ft	mm	in
EXA1769	0.879	0.590	331.77	13.06

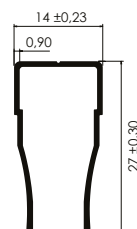

"U" LIVIANA
Lightweight "U" Channel

REF.	Peso / Weight		PER.	
	kg/m	lb/ft	mm	in
S596	0.164	0.110	134.86	5.30

Riel de Closet *Closet Railing*

Closet Railing

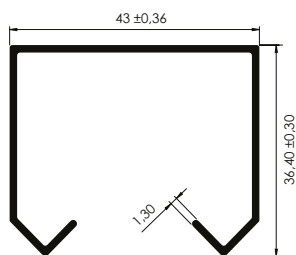

RIEL DE CLOSET
Closet Hanging Rail

REF.	Peso / Weight		PER.	
	kg/m	lb/ft	mm	in
S391	0.462	0.310	262.26	10.32

Divisiones de Oficina *Office Divisions*

Office Divisions

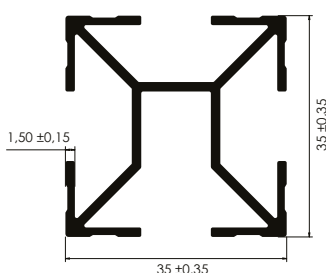

SOPORTE CENTRAL
Center Post

REF.	Peso / Weight		PER.	
	kg/m	lb/ft	mm	in
EXA405	0.706	0.474	349.4	13.75

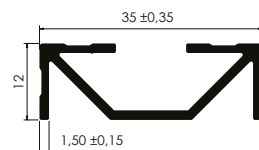

MEDIO SOPORTE CENTRAL
Half Center Post

REF.	Peso / Weight		PER.	
	kg/m	lb/ft	mm	in
EXA-A405	0.330	0.221	164.9	6.49

Zócalos Skirting Boards

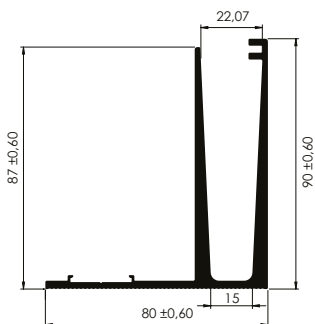

ZÓCALO VIDRIO TEMPLADO
Tempered Glass Skirting Board

REF.	Peso / Weight		PER.	
	kg/m	lb/ft	mm	in
S001	2.727	1.832	528.99	20.82

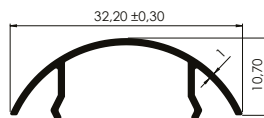

TAPA ZÓCALO
Skirting Board Cover

REF.	Peso / Weight		PER.	
	kg/m	lb/ft	mm	in
S002	0.151	0.101	111.26	4.38

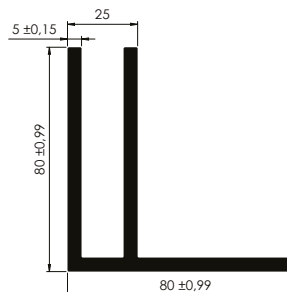

ZÓCALO PARA BARANDA
Skirting Board for Handrail

REF.	Peso / Weight		PER.	
	kg/m	lb/ft	mm	in
S003	3.116	2.093	467.9	18.42

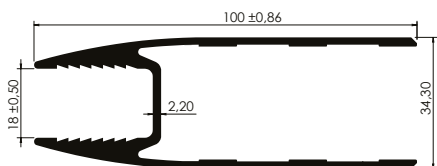

ZÓCALO 100mm
100mm Skirting Board

REF.	Peso / Weight		PER.	
	kg/m	lb/ft	mm	in
S351L	1.676	1.126	485.05	19.09

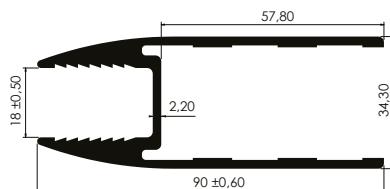

ZÓCALO 90mm
90mm Skirting Board

REF.	Peso / Weight		PER.	
	kg/m	lb/ft	mm	in
S369	1.797	1.207	447.99	17.63

Disipador de Calor Heat Sink

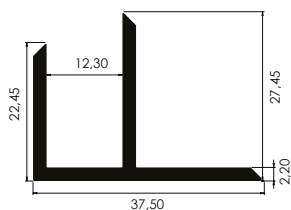

"F" PARA VIDRIO TEMPLADO
"F" for Tempered Glass

REF.	Peso / Weight		PER.	
	kg/m	lb/ft	mm	in
S463	0.502	0.337	166.2	6.54

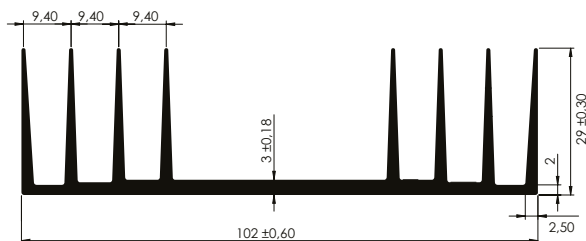

DISIPADOR DE CALOR
Heat Sink

REF.	Peso / Weight		PER.	
	kg/m	lb/ft	mm	in
DIS001	1.715	1.152	612.1	24.09

Perfiles de Exportación

Exporting Profiles

Perfiles Gruesos *Thickened Profiles*

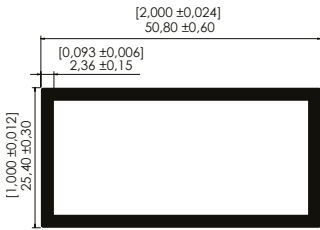

TUBULAR 2" X 1"
2" x 1" Hollow Tube

REF.	Peso / Weight		PER.	
	kg/m	lb/ft	mm	in
EU001	0.914	0.614	285.23	11.23

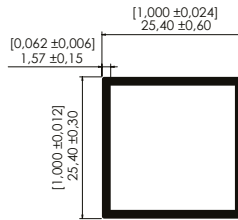

TUBULAR 1" X 1"
1" x 1" Hollow Tube

REF.	Peso / Weight		PER.	
	kg/m	lb/ft	mm	in
EU002	0.405	0.272	189.95	7.47

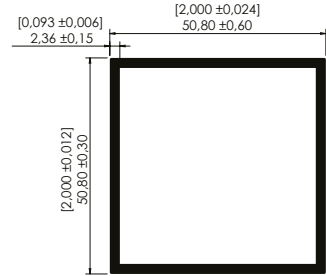

TUBULAR 2" X 2"
2" x 2" Hollow Tube

REF.	Peso / Weight		PER.	
	kg/m	lb/ft	mm	in
EU003	1.239	0.832	386.83	15.23

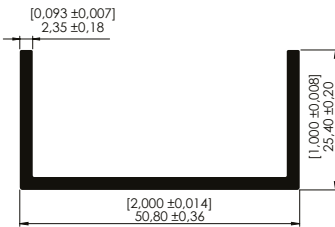

CANAL 2" X 1"
2" x 1" Channel

REF.	Peso / Weight		PER.	
	kg/m	lb/ft	mm	in
EU004	0.617	0.414	197.3	7.67

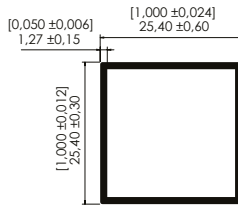

TUBULAR 1" X 1"
1" x 1" Hollow Tube

REF.	Peso / Weight		PER.	
	kg/m	lb/ft	mm	in
EU005	0.332	0.223	192.35	7.57

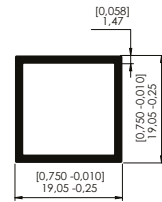

TUBULAR 3/4" X 3/4"
3/4" x 3/4" Hollow Tube

REF.	Peso / Weight		PER.	
	kg/m	lb/ft	mm	in
EU006	0.281	0.188	139.8	5.50

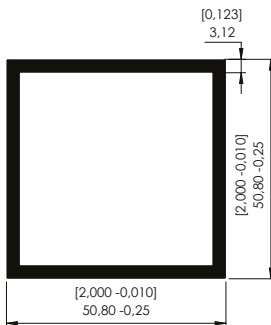

TUBULAR 2" X 2"
2" x 2" Hollow Tube

REF.	Peso / Weight		PER.	
	kg/m	lb/ft	mm	in
EU007	1.614	1.084	380.64	14.98

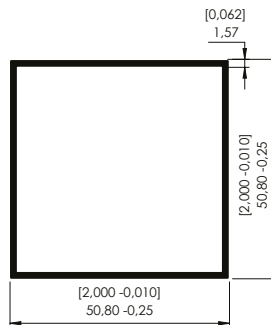

TUBULAR 2" X 2"
2" x 2" Hollow Tube

REF.	Peso / Weight		PER.	
	kg/m	lb/ft	mm	in
EU008	0.840	0.564	393	15.47

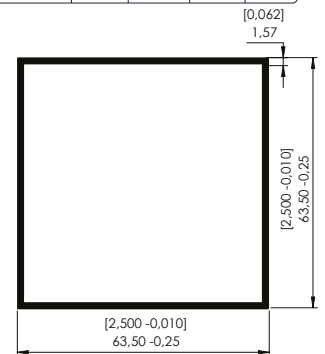

TUBULAR 2-1/2" X 2-1/2"
2-1/2" x 2-1/2" Hollow Tube

REF.	Peso / Weight		PER.	
	kg/m	lb/ft	mm	in
EU009	1.189	0.798	493	19.41

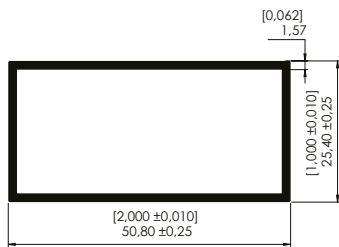

TUBULAR 2" X 1"
2" x 1" Hollow Tube

REF.	Peso / Weight		PER.	
	kg/m	lb/ft	mm	in
EU010	0.623	0.418	291.4	11.47

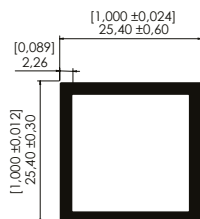

TUBULAR 1" X 1"
1" x 1" Hollow Tube

REF.	Peso / Weight		PER.	
	kg/m	lb/ft	mm	in
EU011	0.567	0.381	184.4	7.26

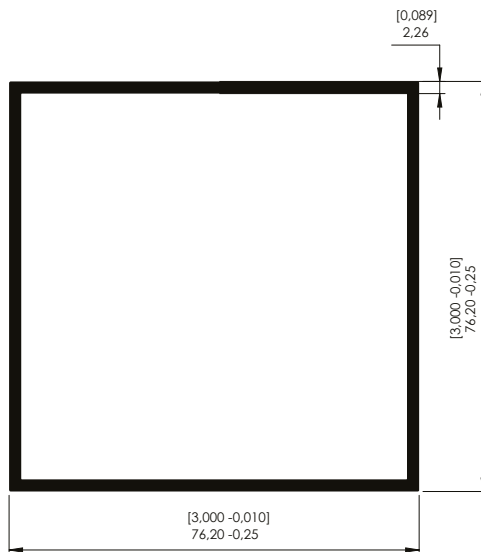

TUBULAR 3" X 3"
3" x 3" Hollow Tube

REF.	Peso / Weight		PER.	
	kg/m	lb/ft	mm	in
EU012	1.811	1.216	590.8	23.26

Cerramientos de Patio *Patio Enclosures*

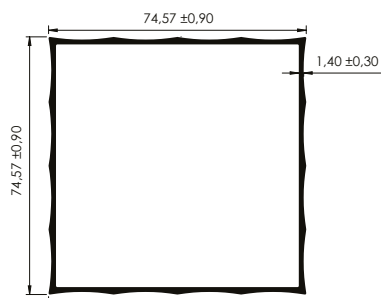

TUBULAR 3" X 3"
3" x 3" Hollow Tube

REF.	Peso / Weight		PER.	
	kg/m	lb/ft	mm	in
AS001	1.286	0.864	579.25	22.80

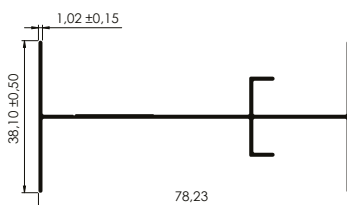

REF.	Peso / Weight		PER.	
	kg/m	lb/ft	mm	in
AS002	0.498	0.334	361.82	14.24

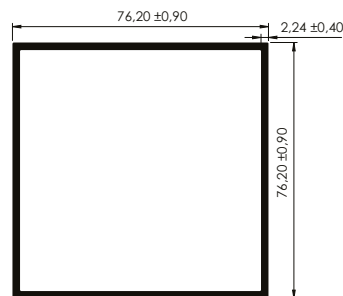

TUBULAR 3" X 3"
3" x 3" Hollow Tube

REF.	Peso / Weight		PER.	
	kg/m	lb/ft	mm	in
AS003	1.789	1.202	590.31	23.24

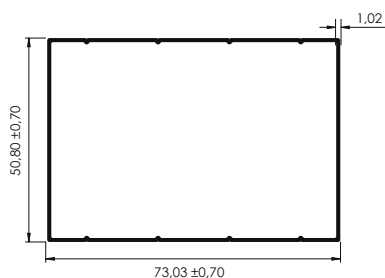

REF.	Peso / Weight		PER.		NUEVO
	kg/m	lb/ft	mm	in	
AS004	0.681	0.457	248.3	9.77	

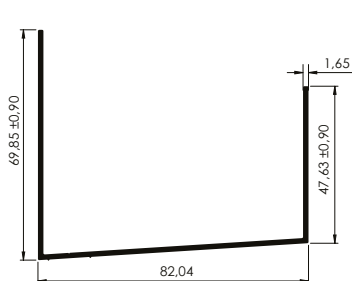

CABEZAL 3"
3" Extruded Header

REF.	Peso / Weight		PER.	
	kg/m	lb/ft	mm	in
AS005	0.875	0.587	395.52	15.57

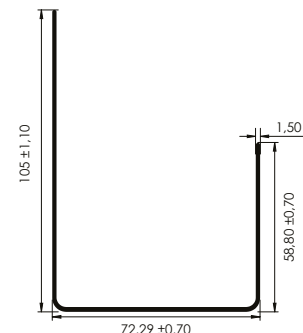

REF.	Peso / Weight		PER.		NUEVO
	kg/m	lb/ft	mm	in	
AS006	0.966	0.649	460.54	18.13	

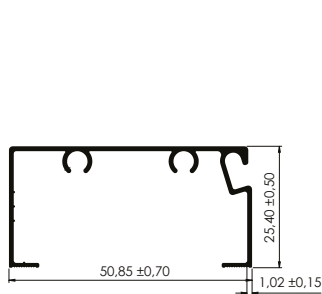

COLUMNA ABIERTA 2" X 1"
2" x 1" Flat Spine Groove (Open Back)

REF.	Peso / Weight		PER.	
	kg/m	lb/ft	mm	in
AS007	0.384	0.258	271.12	10.67

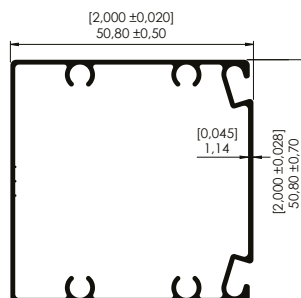

COLUMNA 2" X 2"
2" x 2" Flat Spine Groove

REF.	Peso / Weight		PER.	
	kg/m	lb/ft	mm	in
AS008	0.730	0.490	485.34	19.10

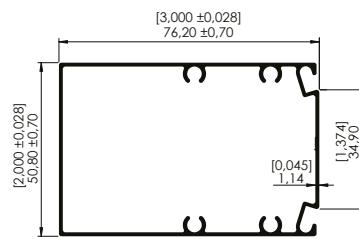

COLUMNA 2" X 3"
2" x 3" Flat Spine Groove

REF.	Peso / Weight		PER.	
	kg/m	lb/ft	mm	in
AS009	0.968	0.650	587.69	23.13

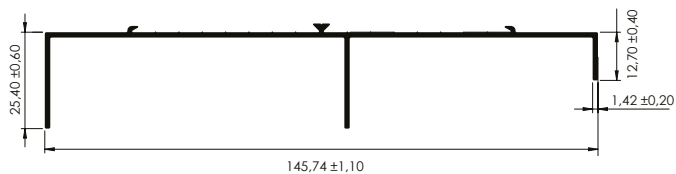

FASCIA 5-1/2"
5-1/2" Extruded Fascia

REF.	Peso / Weight		PER.	
	kg/m	lb/ft	mm	in
AS010	0.843	0.566	432.27	17.01

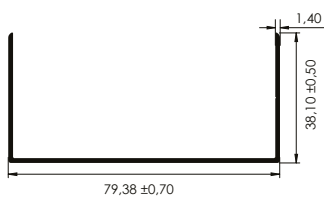

REF.	Peso / Weight		PER.		NUEVO
	kg/m	lb/ft	mm	in	
AS011	0.573	0.385	306.18	12.05	

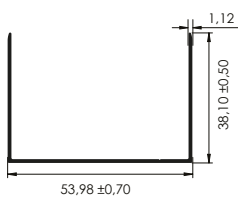

REF.	Peso / Weight		PER.		NUEVO
	kg/m	lb/ft	mm	in	
AS012	0.384	0.258	256.34	10.09	

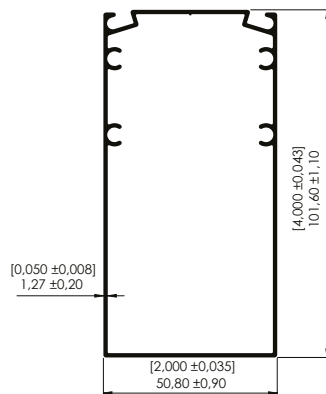

COLUMNA 4" X 2"
4" x 2" Flat Spine Groove

REF.	Peso / Weight		PER.	
	kg/m	lb/ft	mm	in
AS020	1.199	0.806	676.14	26.62

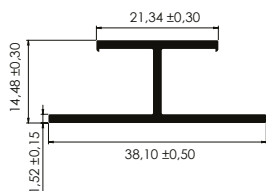

CONECTOR T
T-Connector

REF.	Peso / Weight		PER.	
	kg/m	lb/ft	mm	in
AS022	0.293	0.196	145.29	5.72

Perfiles para estructura de Energía Solar

Solar Energy Structure Profiles

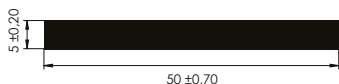

UNIONE
Unione

REF.	Peso / Weight		PER.		NUEVO
	kg/m	lb/ft	mm	in	
R6940	0.675	0.453	110	4.33	

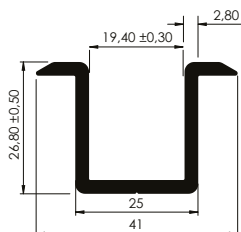

OMEGA FOTOVOL
Omega Fotovolt

REF.	Peso / Weight		PER.		NUEVO
	kg/m	lb/ft	mm	in	
R6941	0.644	0.432	176.37	6.94	

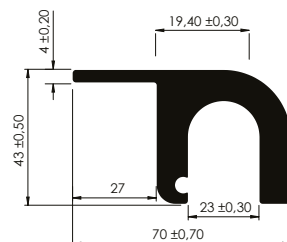

ACCES. PER LAMIERE
Acces. per Lamiere

REF.	Peso / Weight		PER.		NUEVO
	kg/m	lb/ft	mm	in	
R6964	3.046	2.046	274.59	10.81	

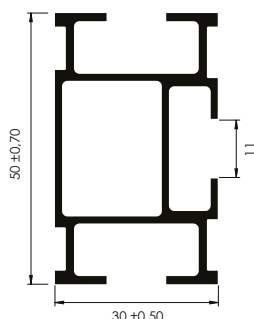

OMNIA STRONG
Omnia Strong

REF.	Peso / Weight		PER.		NUEVO
	kg/m	lb/ft	mm	in	
R6970	0.818	0.549	304.79	11.99	

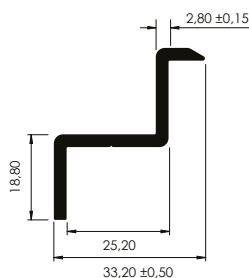

Z PANEL
Panel Z

REF.	Peso / Weight		PER.		NUEVO
	kg/m	lb/ft	mm	in	
R7003	0.499	0.335	137.26	5.40	

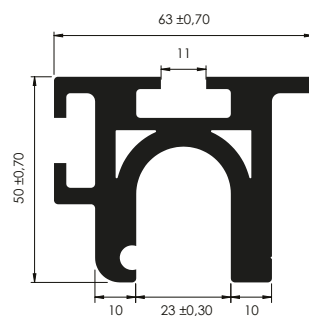

CLIP
Clip

REF.	Peso / Weight		PER.		NUEVO
	kg/m	lb/ft	mm	in	
R7033	3.494	2.347	365.49	14.38	

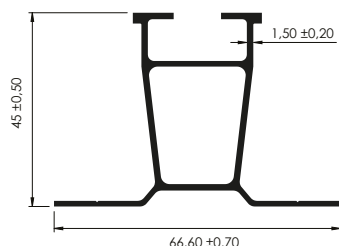

MINI RIEL
Mini Rail

REF.	Peso / Weight		PER.		NUEVO
	kg/m	lb/ft	mm	in	
R7209	0.751	0.504	280.98	11.06	

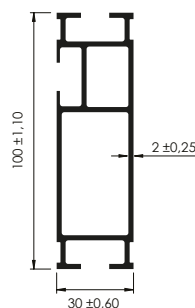

STRUT. FOTOVOLTAICO
Fotovoltaic Strut.

REF.	Peso / Weight		PER.		NUEVO
	kg/m	lb/ft	mm	in	
R7215	1.752	1.177	402.03	15.82	

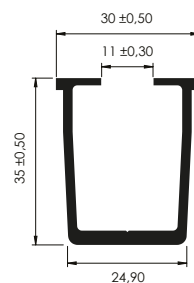

MICRO RIEL
Micro Rail

REF.	Peso / Weight		PER.		NUEVO
	kg/m	lb/ft	mm	in	
R7330	0.614	0.412	210.91	8.30	

¿No Encuentras el
Perfil *Can't find what you
are looking for?*
que estás
buscando?



Si el perfil que está buscando no está en catálogo, lo desarrollamos a su medida.

If the profile you are looking for is not in the catalog, we can develop it for you.

Tipos de Acabados

Finishes Options



Pintura Electroestática

Powder Coating



Contamos en nuestra planta con un equipo de pintura electroestática o lacado en polvo automatizada para crear un acabado duro mas resistente que la pintura convencional. Con nuestra alta eficiencia en la aplicación podemos ofrecer variedades de colores.

We have an automated electrostatic painting or powder coating equipment in our plant to create a hard finish that is more resistant than conventional painting. With our high application efficiency we can offer varieties of colors.

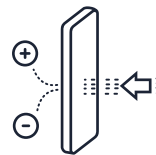
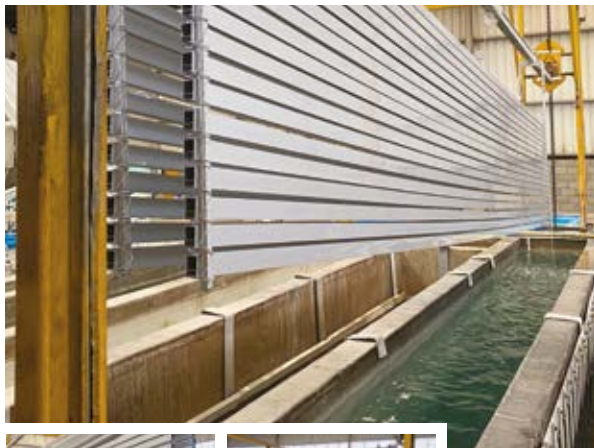

Anodizado

Anodizing

Proceso electroquímico que crea una capa gruesa de óxido natural y esto logra una completa protección contra la corrosión, resistencia a la abrasión, aislamiento a la electricidad y un mejoramiento estético en el acabado.

Electrochemical processes that create a thick layer of natural oxide and this achieves complete protection against corrosion, resistance to abrasion, insulation to electricity and an aesthetic improvement in the finish.



EXTRUSORA DE ALUMINIO

+57 (318) 5328329(Col)
+1 (954) 5544282 (USA)

jjexal@gmail.com
fangulo@exal.com.co
graad@exal.com.co

Barranquilla, Colombia

WWW.EXAL.COM.CO